

Powered by



GPL 12400 ▶ 12V 40Ah

GPL 12400 is a general purpose battery up to 10 years in standby service or more than 260 cycles at 100% discharge in cycle service . As with all CSB batteries, all are rechargeable , highly efficient , leak proof and maintenance free.



Specification

Cells Per Unit	6
Voltage Per Unit	12
Capacity	40 Ah @ 20hr-rate to 1.75V per cell @25 °C (77°F)
Weight	Approx. 14.5 kg(32.0 lbs)
Maximum Discharge Current	400A(5sec)
Internal Resistance	Approx. 7 mΩ
Operating Temperature Range	Discharge: -15°C~50°C (5°F~122°F) Charge: -15 °C~40°C (5°F~104°F) Storage: -15°C~40°C (5°F~104°F)
Nominal Operating Temperature Range	25°C±3°C (77°F±5°F)
Float Charging Voltage	13.5 to 13.8 VDC/unit Average at 25°C (77°F)
Recommended Maximum Charging Current Limit	12 A
Equalization and Cycle Service	14.4 to 15.0 VDC/unit Average at 25°C (77°F)
Self Discharge	CSB Batteries can be stored for more than 6 months at 25°C (77°F) . Please charge batteries before using . For higher temperatures the time interval will be shorter.
Terminal	B2-L terminal to accept M5 nut & bolt
Container Material	ABS(UL 94-HB/File E50263)*Flammability resistance of (UL 94-V0/File E88637) can be available upon request.



MH14533(N)



No :041005117



CSB-manufactured batteries are UL-recognized components under UL924 and UL1989. CSB is also certified by ISO 9001 and ISO 14001.

Dimensions :

Overall Height (H)	Container height (h)	Length (L)	Width (W)
Unit: mm (inch)	170±2 (6.69±0.08)	168.5±2 (6.63±0.08)	197±2 (7.76±0.08)

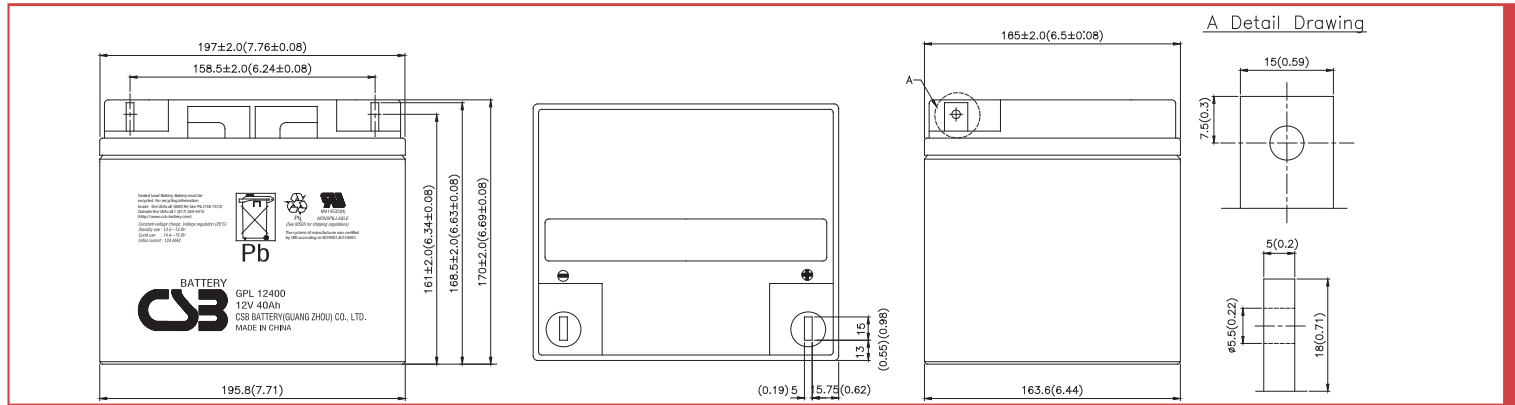

Constant Current Discharge Characteristics Unit:A (25°C ,77°F)

F.V/Time	5MIN	10MIN	15MIN	30MIN	1HR	2HR	3HR	4HR	5HR	8HR	10HR	20HR
1.60V	162	104	78.2	47.7	28.1	16.3	11.6	9.04	7.37	4.83	3.94	2.03
1.67V	145	96.5	74.5	46.7	27.9	16.2	11.5	8.99	7.34	4.78	3.86	1.95
1.70V	137	92.8	72.4	46.1	27.8	16.1	11.4	8.97	7.33	4.76	3.83	1.91
1.75V	124	87.4	69.5	45.0	27.6	16.0	11.3	8.93	7.30	4.69	3.77	1.84
1.80V	111	81.3	65.9	43.8	27.4	15.9	11.2	8.90	7.26	4.63	3.71	1.78
1.85V	98.1	75.1	62.4	42.5	27.0	15.8	11.1	8.86	7.22	4.56	3.64	1.71

Constant Power Discharge Characteristics Unit:W (25°C ,77°F)

F.V/Time	5MIN	10MIN	15MIN	30MIN	1HR	2HR	3HR	4HR	5HR	8HR	10HR	20HR
1.60V	1,941	1,242	938	572	338	195	139	109	88.4	58.0	47.2	24.4
1.67V	1,735	1,158	895	558	335	194	138	108	88.1	57.3	46.4	23.3
1.70V	1,647	1,117	869	552	334	193	137	107	87.9	57.0	46.0	22.9
1.75V	1,490	1,049	830	539	331	192	136	106	87.5	56.3	45.2	22.1
1.80V	1,334	975	791	525	328	191	135	105	87.2	55.6	44.4	21.3
1.85V	1,178	902	749	510	324	190	134	104	86.7	54.8	43.7	20.6

Trickle (or Float) Service Life

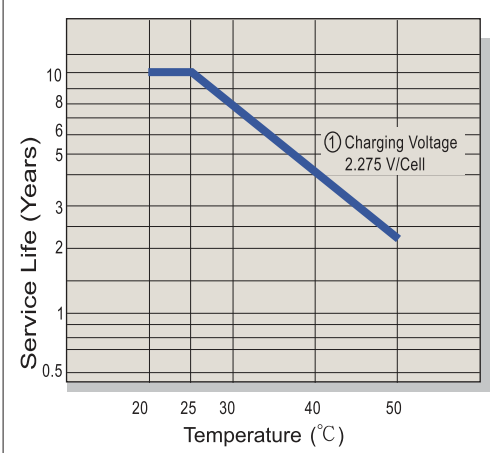

Capacity Retention Characteristic

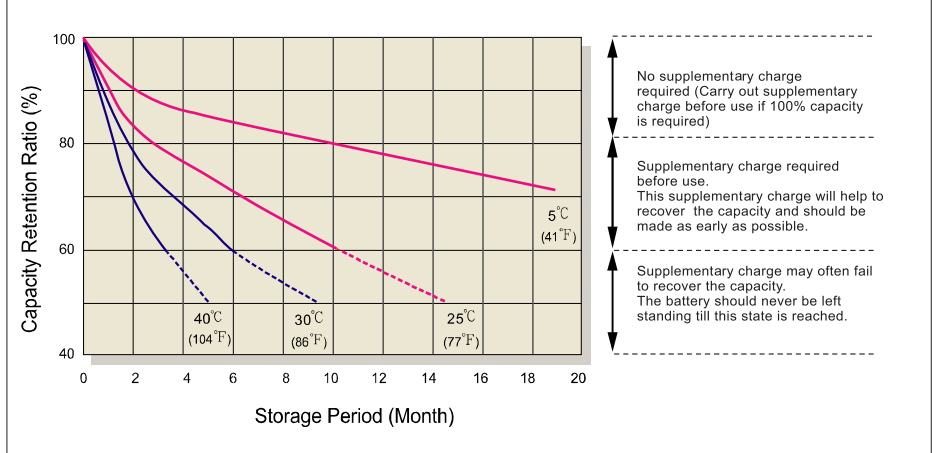

Battery Voltage and Charge Time for Standby Use

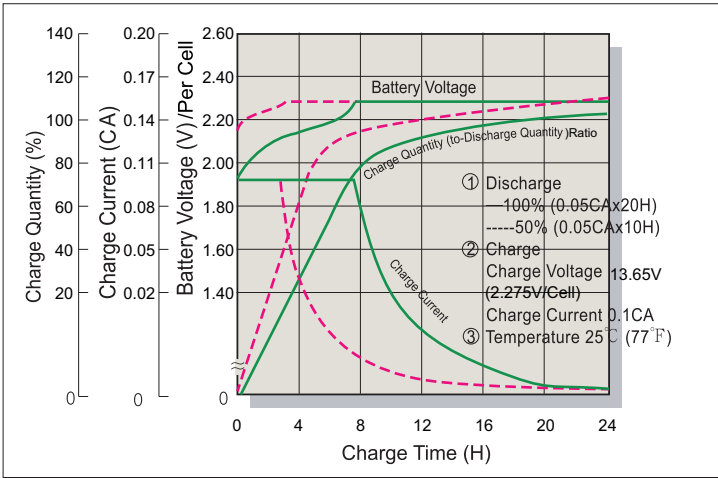

Cycle Service Life

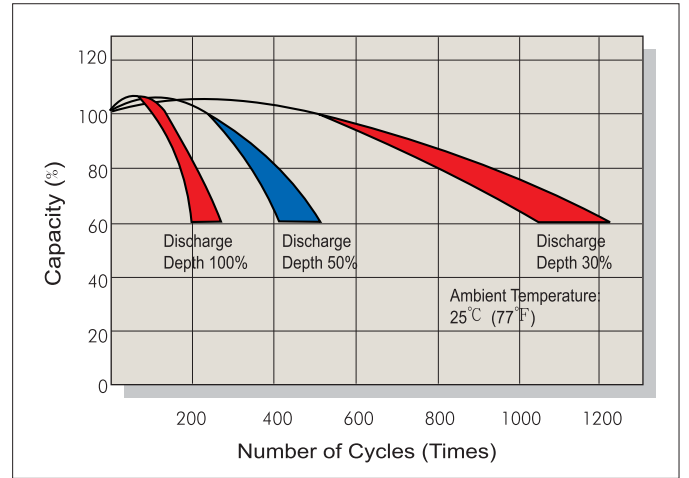

Battery Voltage and Charge Time for Cycle Use

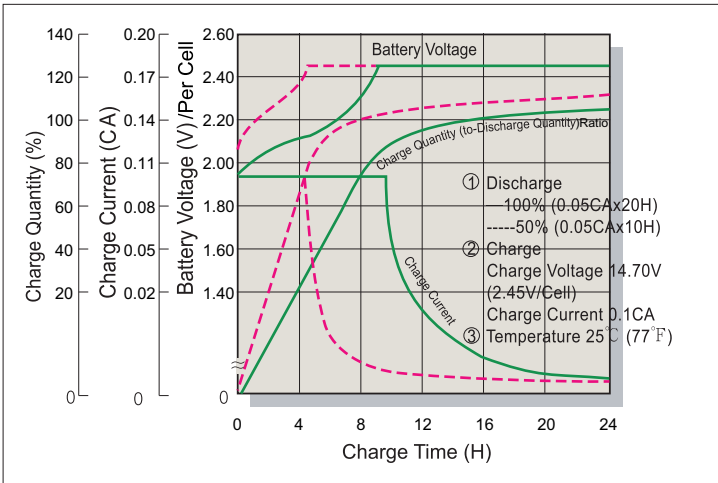

Terminal Voltage (V) and Discharge Time

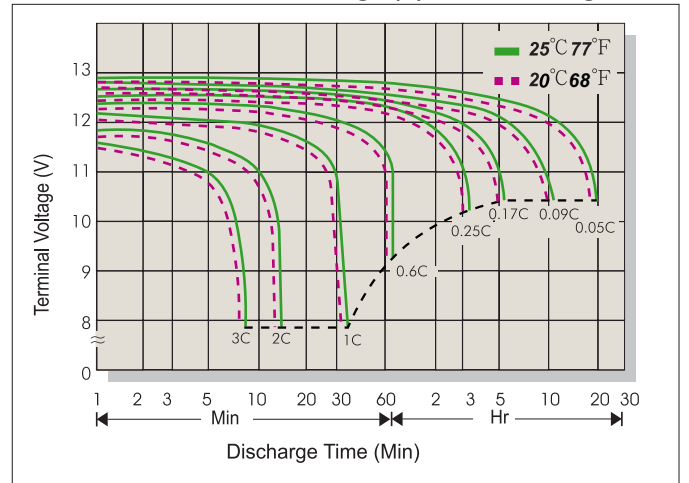

Charging Procedures

Application	Charge Voltage(V/Cell)			Max.Charge Current
	Temperature	Set Point	Allowable Range	
Cycle Use	25°C(77°F)	2.45	2.40~2.50	0.3C
Standby	25°C(77°F)	2.275	2.25~2.30	

Discharge Current VS. Discharge Voltage

Final Discharge Voltage V/Cell	1.75	1.70	1.60	1.30
Discharge Current(A)	0.2C>(A)	0.2C<(A)<0.5C	0.5C<(A)<1.0C	(A)>1.0C

Sales Office URL: WWW.CSB-BATTERY.COM

GLOBAL HQ
CSB BATTERY CO., LTD. (TAIWAN)
 Tel : +886-2-2555-5600
 Fax : +886-2-2555-3300
 mail : service@csb-battery.com.tw

BEIJING OFFICE. (CHINA)
CSB BATTERY TECHNOLOGIES (BEIJING) CO., LTD.
 Tel : +86-10-59621300/1301/1302/1303
 Fax : +86-10-59621304
 mail : chinasls@csb-battery.com

AMERICA HQ
CSB BATTERY TECHNOLOGIES INC. (U.S.A)
 Tel : +1-817-244-7777/1-(800)3-CSB-USA(272872)
 Fax : +1-817-244-4445
 mail : csb@csb-battery.com

SHANGHAI OFFICE. (CHINA)
CSB BATTERY LOGISTIC (SHANGHAI) CO., LTD.
 Tel : +86-21-5046-1622/5046-0833
 Fax : +86-21-5064-3314
 mail : chinasls@csb-battery.com

EUROPE HQ
CSB Battery Europe BV.
 Tel : +31(0)-180-418-140
 Fax : +886-2-2555-3300
 mail : eurossales@csb-battery.eu

SHENZHEN OFFICE. (CHINA)
CSB BATTERY LOGISTIC (SHANGHAI) CO., LTD.
 Tel : +86-755-8831-6488/6396/6356
 Fax : +86-755-8831-6548
 mail : she@csb-battery.com.cn